

THE NEW VALUE FRONTIER



# MFWN SERIES

## New high efficient 90° milling tool

- Economical 6 edges
- Long tool life with MEGACOAT NANO

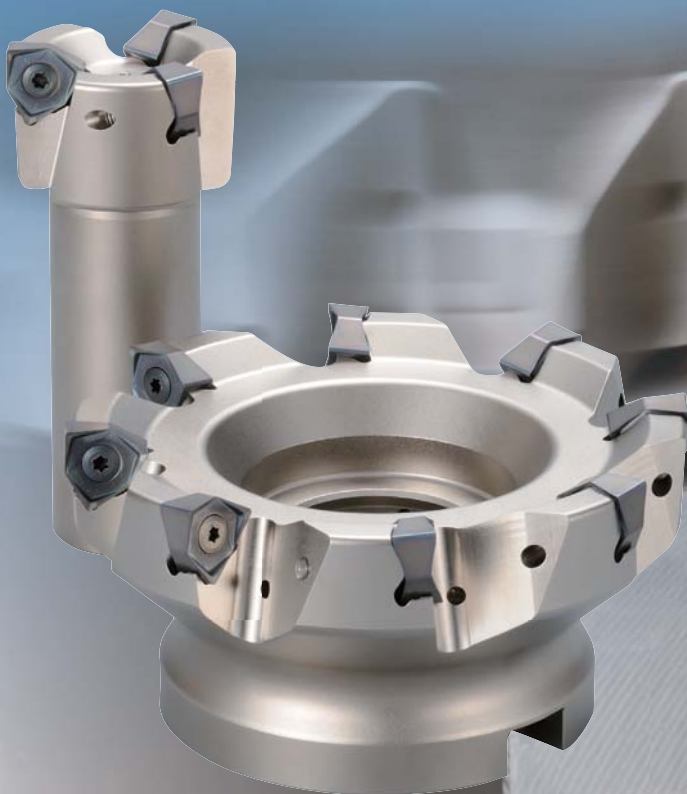

### Nouvelle fraise performante à surfaçer dresser 90°

- 6 arêtes économiques.
- Durée vie accrue avec Megacoat Nano.

### Nuova fresa a 90° ad elevata efficienza

- Economica: 6 taglienti.
- Lunga vita utensile con Megacoat Nano.

### Nueva herramienta fresadora de 90° de alta eficiencia

- Económico – 6 puntas.
- Larga vida de herramienta con Megacoat Nano.

TZZ00048

ADVANCING PRODUCTIVITY



- Low cutting force due to large rake angle.
- Faible effort en raison d'un angle de coupe très positif.
- Basse forze di taglio per mezzo dell'ampio angolo di attacco.
- Baja fuerza de corte por su gran ángulo de corte.

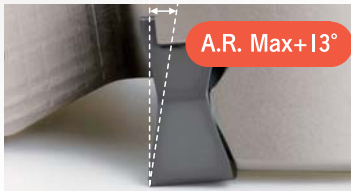

- Dynamic Slant Design reduces impact force when cutting edge enters the workpiece.
- L'hélice optimisée permet d'améliorer l'entrée dans la pièce usinée en réduisant les chocs.
- Design ad inclinazione dinamica riduce lo shock durante la fase di contatto del pezzo.
- Diseño Sesgado Dinámico reduce impacto de choque cuando la punta de corte penetra la pieza de trabajo.

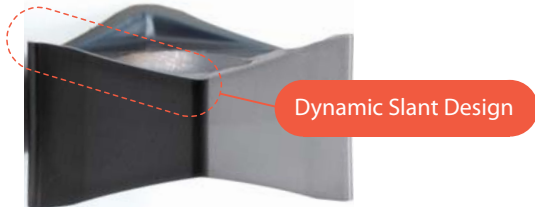

### Surface Roughness

Etat de surface  
Rugosità superficiale  
Aspereza de Superficie

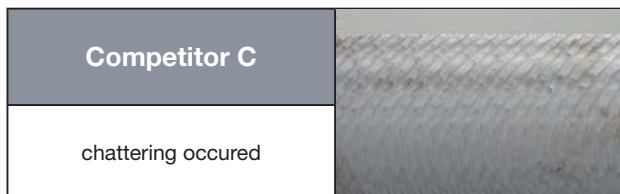
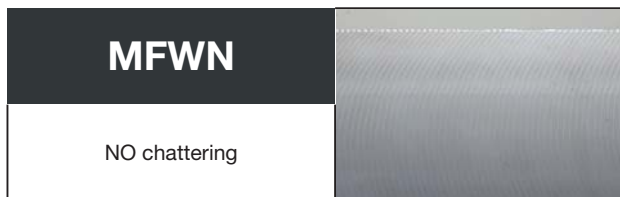

- Economical double-sided 6-edge insert.
- Plaquette économique réversible à 6 arêtes.
- Inserto bilaterale economico a 6 taglienti.
- Placa económica 6 puntas de doble cara.

### Cutting Force

Efforts de coupe  
Forza di taglio  
Fuerza de Corte

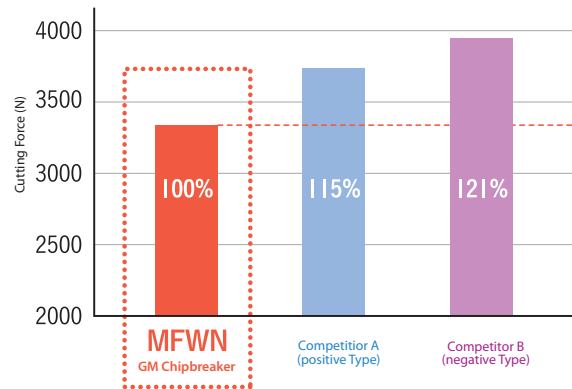

Vc = 180m/min apxae = 7x110 mm fz = 0.2mm/t  
Workpiece Material: C50 Cutter Ø 125mm

### Cutting Noise

Bruit d'usinage  
Rumore di taglio  
Ruido de corte

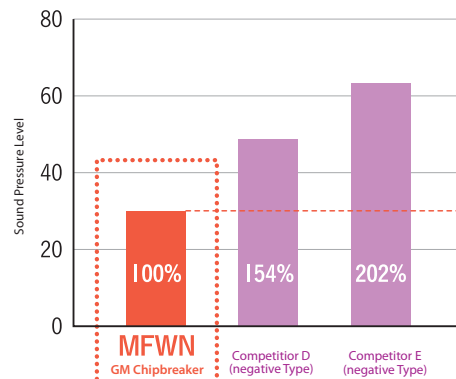

Vc = 200m/min apxae = 3x15 mm fz = 0.1mm/t  
Workpiece Material: C50 Cutter Ø 80mm 7teeth



**MEGACOAT NANO for Extended Tool Life**  
 MEGACOAT NANO pour optimiser la durée de vie  
 MEGACOAT NANO per incrementare la vita utensile  
 MEGACOAT NANO para vida de herramienta extendida



- PR1525 for steel and stainless steel. PR1510 for cast iron
- PR1525 pour les aciers et inox. PR1510 pour les fontes.
- PR1525 per acciaio e acciaio inossidabile. PR1510 per ghisa.
- PR1525 para acero y acero inoxidable. PR1510 para acero fundido.

- High hardness and superior oxidation resistance
- Dureté supérieure et meilleur résistance à l'oxydation.
- Elevata durezza e superiore resistenza all'ossidazione.
- Alta dureza y superior resistencia a la oxidación.

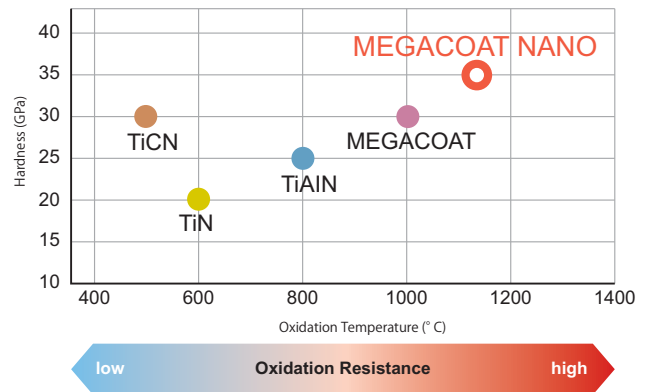

**Fracture Resistance**  
 Résistance à la rupture  
 Resistenza alla frattura  
 Resistencia a Fracturas

Vc = 100m/min, apxae = 2x100 mm, fz = 0.2-0.45mm/t  
 Workpiece Material: 42CrMo4 (38~42HS), DRY  
 Interruption with a slot on the workpiece

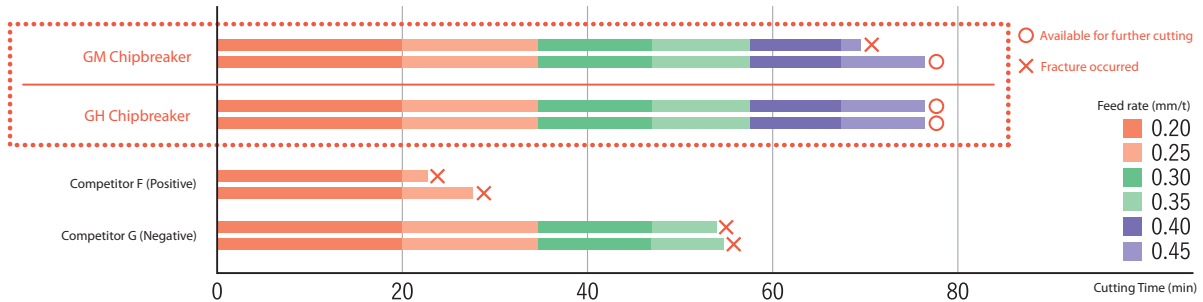

Stable clamping with optimal insert face design.  
 Fixation optimisée pour une meilleure stabilité de la plaquette.  
 Bloccaggio stabile attraverso il design ottimizzato sul petto dell'inserto.  
 Fijación estable con un diseño óptimo de cara de placa.

**4 Chipbreakers for Various Application**  
 4 géométries pour les différentes applications  
 4 rompitrucioli per varie applicazioni  
 4 Rompevirutas para Varias Aplicaciones

Chipbreaker	Application	Shape
GM	General Purpose	
SM	Low Cutting Force	
GH	Heavy Milling	
GL	Surface-Finish Oriented	

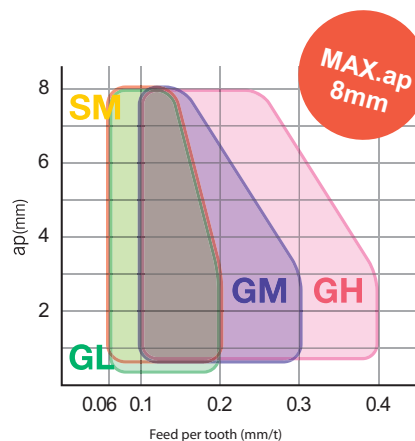

# MFWN Face Mill

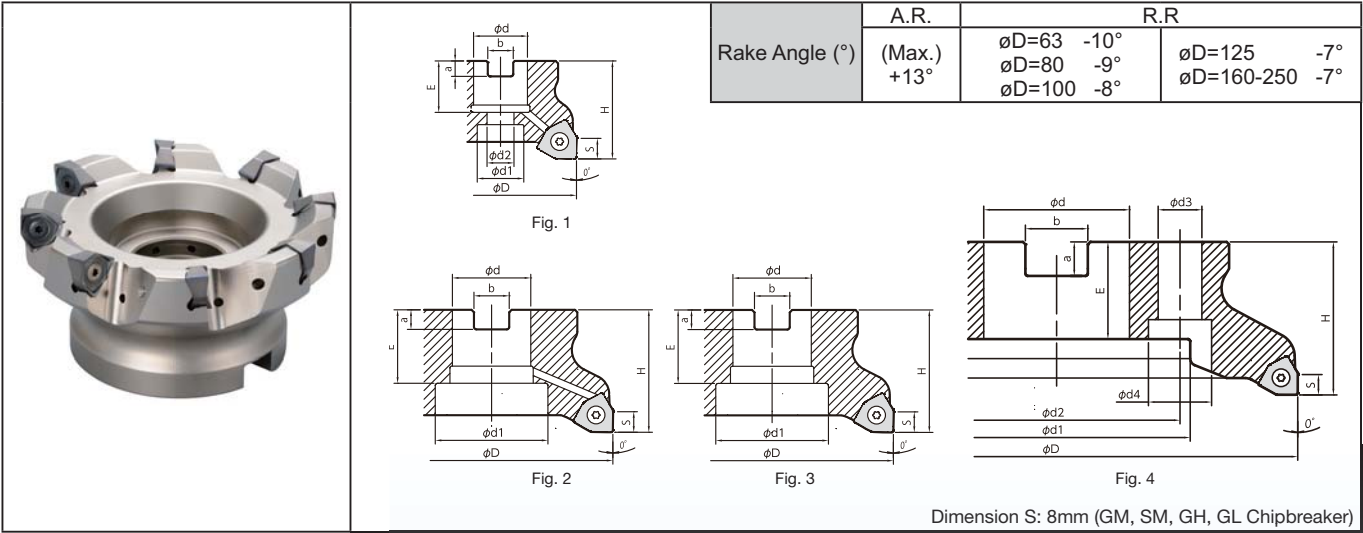

Dimension S: 8mm (GM, SM, GH, GL Chipbreaker)

## Toolholder Dimension

Description		Standard	No of Insert	Dimension (mm)									Drawing	(kg) weight	Shim	Coolant Hole		
				øD	ød	ød1	ød2	H	E	a	b	ød3					ød4	
METRIC	Coarse Pitch	MFWN 90063R-3T-M	●	3	63	22	19	11	40	21	6.3	10.4			Fig.1	0.5	Yes	Yes
		90080R-4T-M	●	4	80	27	20	13	50	24	7	12.4			Fig.1	1.0		
		90100R-5T-M	●	5	100	32	46	-	50	30	8	14.4			Fig.2	1.3		
		90125R-6T-M	●	6	125	40	55	-	63	33	9	16.4			Fig.2	2.5		
		90160R-8T-M	●	8	160	40	68	66.7	63	32	9	16.4	14	20	Fig.4	3.8		
		90200R-10T-M	●	10	200	60	110	101.6	63	40	14	25.7	18	26	Fig.4	6.0		
	90250R-12T-M	●	12	250	60	110	101.6	63	40	14	25.7	18	26	Fig.4	8.4			
	Fine Pitch	MFWN 90063R-4T-M	●	4	63	22	19	11	40	21	6.3	10.4			Fig.1	0.5	No	Yes
		90080R-5T-M	●	5	80	27	20	13	50	24	7	12.4			Fig.1	1.0		
		90100R-7T-M	●	7	100	32	46	-	50	30	8	14.4			Fig.2	1.3		
		90125R-8T-M	●	8	125	40	55	-	63	33	9	16.4			Fig.2	2.6		
		90160R-10T-M	●	10	160	40	68	66.7	63	32	9	16.4	14	20	Fig.4	3.9		
		90200R-12T-M	●	12	200	60	110	101.6	63	40	14	25.7	18	26	Fig.4	6.3		
	90250R-14T-M	●	14	250	60	110	101.6	63	40	14	25.7	18	26	Fig.4	8.7			
	Extra Fine Pitch	MFWN 90063R-5T-M	●	5	63	22	19	11	40	21	6.3	10.4			Fig.1	0.5	No	Yes
		90080R-7T-M	●	7	80	27	20	13	50	24	7	12.4			Fig.1	1.1		
		90100R-9T-M	●	9	100	32	46	-	50	30	8	14.4			Fig.2	1.3		
		90125R-12T-M	●	12	125	40	55	-	63	33	9	16.4			Fig.2	2.6		
90160R-14T-M		●	14	160	40	68	66.7	63	32	9	16.4	14	20	Fig.4	3.9			
90200R-16T-M		●	16	200	60	110	101.6	63	40	14	25.7	18	26	Fig.4	6.4			
90250R-18T-M	●	18	250	60	110	101.6	63	40	14	25.7	18	26	Fig.4	8.8				
INCH	Coarse Pitch	MFWN 90080R-4T	□	4	80	25.4	20	13	50	27	6	9.5			Fig.1	1.0	Yes	Yes
		90100R-5T	□	5	100	31.75	46	-	50	34	8	12.7			Fig.2	1.3		
		90125R-6T	□	6	125	38.1	55	-	63	38	10	15.9			Fig.2	2.6		
		90160R-8T	□	8	160	50.8	72	-	63	38	11	19.1			Fig.3	3.9		
		90200R-10T	□	10	200	47.625	110	101.6	63	40	14	25.4	18	26	Fig.4	6.3		
		90250R-12T	□	12	250	47.625	110	101.6	63	40	14	25.4	18	26	Fig.4	8.7		
	Fine Pitch	MFWN 90080R-5T	□	5	80	25.4	20	13	50	27	6	9.5			Fig.1	1.0	No	Yes
		90100R-7T	□	7	100	31.75	46	-	50	34	8	12.7			Fig.1	1.4		
		90125R-8T	□	8	125	38.1	55	-	63	38	10	15.9			Fig.2	2.7		
		90160R-10T	□	10	160	50.8	72	-	63	38	11	19.1			Fig.3	4.0		
		90200R-12T	□	12	200	47.625	110	101.6	63	40	14	25.4	18	26	Fig.4	6.6		
		90250R-14T	□	14	250	47.625	110	101.6	63	40	14	25.4	18	26	Fig.4	8.9		
	Extra Fine Pitch	MFWN 90080R-7T	□	7	80	25.4	20	13	50	27	6	9.5			Fig.1	1.1	No	Yes
		90100R-9T	□	9	100	31.75	46	-	50	34	8	12.7			Fig.1	1.3		
		90125R-12T	□	12	125	38.1	55	-	63	38	10	15.9			Fig.2	2.7		
		90160R-14T	□	14	160	50.8	72	-	63	38	11	19.1			Fig.3	4.1		
		90200R-16T	□	16	200	47.625	110	101.6	63	40	14	25.4	18	26	Fig.4	6.7		
		90250R-18T	□	18	250	47.625	110	101.6	63	40	14	25.4	18	26	Fig.4	9.1		

● : Std. Item □ : Check Availability

● Spare Parts

Description		Spare Parts								
		Clamp Screw	Wrench		Shim	Shim Screw	Wrench	Anti-seize Compound	Mounting bolt	
			TT	DTM						
Coarse Pitch	MFWN 90063R-3T-M	SB-50140TR	TT-15	-	MFWN-90	SPW-7050	LW-5	MP-1	HH10x30	
	90080R-4T-M								HH12x35	
	90100R-5T-M								-	
	90250R-12T-M								-	
Fine Pitch	MFWN 90063R-4T-M	SB-50140TR	TT-15	-	-	-	-	MP-1	HH10x30	
	90080R-5T-M								HH12x35	
	90100R-7T-M								-	
	90250R-14T-M								-	
Extra Fine Pitch	MFWN 90063R-5T-M	SB-50140TR	TT-15	-	-	-	-	MP-1	HH10x30	
	90080R-7T-M	SB-40140TRN	-	DTM-15					HH12x35	
	90100R-9T-M	3.5 Nm Recommended torque for insert clamp		-					-	-
	90250R-18T-M	3.5 Nm Recommended torque for insert clamp		-					-	-

🔧 Coat Anti-seize Compound (MP-1) thinly on clamp screw.

Recommended cutting conditions see page 7

■ How to replace a shim (for coarse pitch)

- Remove dust and chips from the insert mounting pocket.
- The shim must be mounted in proper direction. While aligning the surface of the shim with the mark on it to the corresponding constraint surface (See Fig. 1) and lightly pressing the shim towards the constraint surface (See Fig. 2). Insert the screw into the hole of the shim and tighten (See Fig. 3). When tightening the screw, make sure that the screw is vertical to the bearing surface (See Fig. 3). recommended torque is 6.0Nm.
- After tightening the screw, make sure that there is no clearance between the shim seat surface and the bearing surface. If there is any clearance, remove the shim and mount it again according to the above steps.

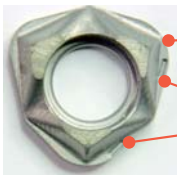

Fig. 1

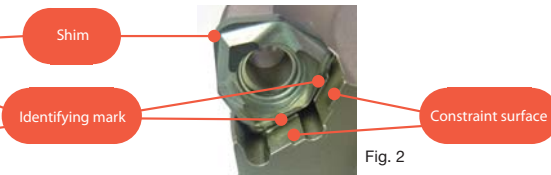

Fig. 2

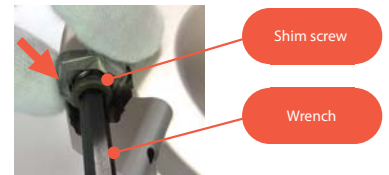
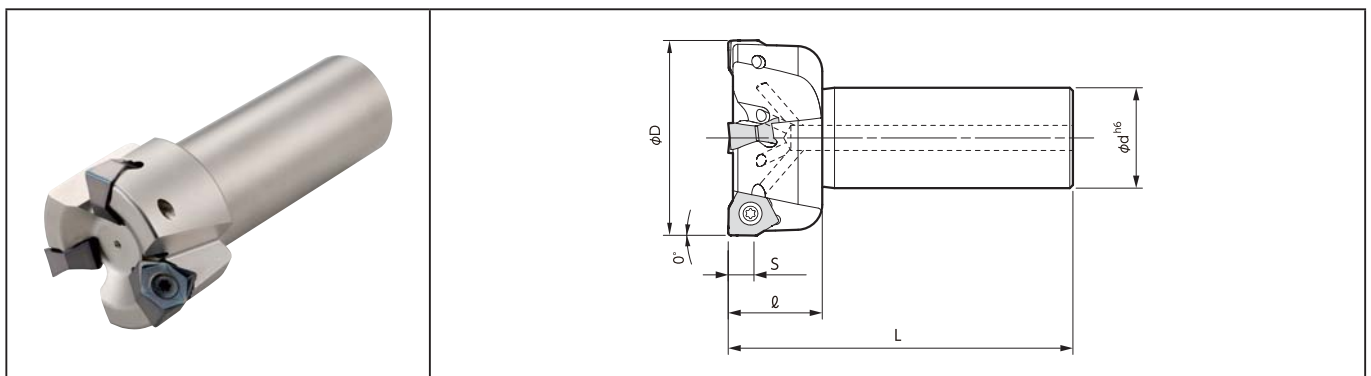

Fig. 3

■ MFWN with shank



● Toolholder Dimension

Description	Standard	No. of Insert	Dimension (mm)					Rake Angle (°)		Coolant Hole	Spare Parts		
			øD	ød	L	ℓ	S	A.R. (MAX)	R.R.		Clamp Screw	Wrench	Anti-seize Compound
MFWN 90050R-S32-3T	<input type="checkbox"/>	3	50	32	110	30	8	+13°	-12°	Yes	SB-50140TR	TT-15	MP-1
90063R-S32-4T	<input type="checkbox"/>	4	63										
90080R-S32-5T	<input type="checkbox"/>	5	80										

🔧 Coat Anti-seize Compound (MP-1) thinly on clamp screw.

● : Std. Item     : Check Availability



## How to mount inserts

1. Remove dust and chips from the insert mounting pocket.
2. After applying anti-seize compound on portion of taper and thread attach the screw to the front end of the wrench. While lightly pressing the insert against the constraint surfaces, put the screw into the hole of the insert and tighten (See Fig. 1).
3. When tightening the screw, make sure that the wrench is parallel to the screw. Remember that the screw hole of the holder for Extra Fine Pitch is inclined to the bearing surface. ( See Fig.2 and Fig.3)  
For recommended torque, refer table on page 5.
4. After tightening the screw, make sure that there is no clearance between the insert seat surface and the bearing surface of the holder or between the insert side surfaces and the constraint surface of the holder. If there is any clearance, remove the insert and mount it again according to the above steps.
5. To change the cutting edge of the insert, turn the insert counterclockwise. (See Fig.4) The insert corner identification is stamped on the top surface of the insert.



Fig. 1

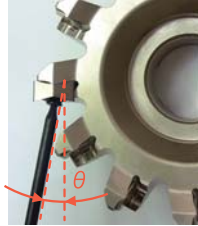

Fig. 2

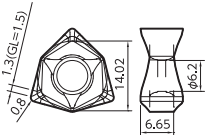





Fig. 3



Fig. 4

## Applicable Inserts

Classification of usage				
★ : Roughing / 1st Choice ☆ : Roughing / 2nd Choice ■ : Finishing / 1st Choice □ : Finishing / 2nd Choice (In case hardness is under 45HRC)	P	Carbon Steel / Alloy Steel	★	
		Mold Steel	★	
	M	Stainless Steel	★	
	K	Gray Cast Iron		★
		Nodular Cast Iron		★
	N	Non-ferrous Metal		
	S	Heat-resistant Alloy	★	
		Titanium Alloy		★
	H	Hard Materials	□	
Insert		Description	MEGACOAT NANO	
			PR1525	PR1510
		WNMU 080608EN-GM	●	●
		WNMU 080608EN-SM	●	●
		WNMU 080608EN-GH	●	●
		WNEU 080608EN-GL	●	●

● : Std. Item □ : Check Availability

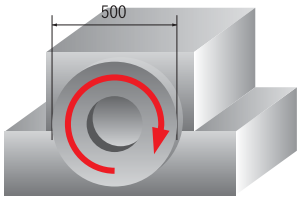

## Case Studies

<b>GG-30</b>	
Machine part Vc=170/min apxae=2.5x130mm fz=0.183mm/t (Vf=500mm/min) with liquid coolant MFWN90160R-8T WNMU080608ER-GM (PR1510)	
<b>PR1510</b>	Chip Removal Rate = 163cc/min
Competitor A (positive type)	Chip Removal Rate = 68cc/min
Competitor proceeded under low cutting conditions, as workpiece was slipping because of the unstable chucking. With MFWN stable cutting was possible at higher cutting conditions.	

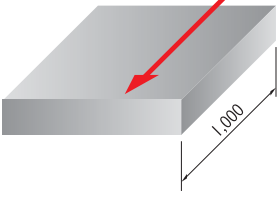
<b>GG-25</b>	
Frame Vc=150/min apxae=4x160mm fz=0.24mm/t (Vf=715mm/min) with air coolant MFWN90160R-10T WNMU080608ER-GM (PR1510)	
<b>PR1510</b>	Chip Removal Rate = 458cc/min (stable milling)
Competitor B (negative type/vertical inserts)	Chip Removal Rate = 282cc/min
While competitor B could not improve the cutting conditions due to chatter, MFWN improved it by 160% with NO chatter.	

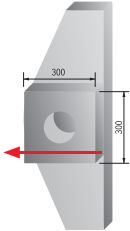
<b>Manganese Steel</b>	
Construction equipment's part Vc=150/min apxae=1x100mm fz=0.2mm/t (Vf=668mm/min) with air coolant MFWN90100R-7T WNMU080608ER-GM (PR1525)	
<b>PR1525</b>	Machining efficiency = 2pc/edge
Competitor C (negative type/vertical inserts)	1pc/edge
Despite instability with the long overhang of workpiece, MFWN doubled tool life, improving the efficiency by 150%.	

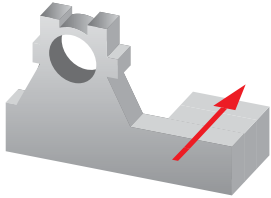
<b>1.0040</b>	
Machine part Vc=226/min apxae=1.5x80mm fz=0.16mm/t (Vf=1,000mm/min) with air coolant MFWN90080R-7T WNMU080608ER-GM (PR1525)	
<b>PR1525</b>	Machining efficiency = 3pc/edge
Competitor D (positive type)	1pc/edge
MFWN tripled tool life under same cutting conditions as Competitor D.	



KYOCERA Fineceramics GmbH  
Cutting Tool Division  
Hammfelddamm 6, 41460 Neuss, Germany  
Phone: +49 (0) 2131 1637-115  
Fax: +49 (0) 2131 1637-152  
www.kyocera.de / www.kyocera.eu  
ceratip@kyocera.de

KYOCERA Fineceramics SAS.  
Cutting Tool Division  
Parc Tertiaire Silic, 21 Rue de Villeneuve  
BP 90439, 94528 Rungis Cedex, France  
Phone: +33 (0) 1 41 73 73 40 Fax: +33 (0) 1 56 72 18 94  
www.kyocera.fr

KYOCERA Fineceramics GmbH Poland Branch Office  
Cutting Tool Division  
Leg. ul. Europejska 4, 55-220, Jelcz-Laskowice, Poland  
Phone: +48-(0) 71-381-12-15 Fax: +48-(0) 71-381-12-16  
www.kyocera.eu

KYOCERA Fineceramics GmbH Italy Branch Office  
Cutting Tool Division  
Via Torino 51, 20123 Milan, Italy  
Phone: +39-02 00620 845 Fax: +39-02 00620 848  
www.kyocera.it

KYOCERA Fineceramics GmbH Spain Branch Office  
Cutting Tool Division  
Avenida Manacor 4, 28290 Las Matas, Madrid, Spain  
Phone: +34-91-631-83-92-802 Fax: +34-91-631-82-19  
www.kyocera.es